

ELEVATOR FIXTURES

Features and Benefits

- Sleek modern design
- Residential and Commercial Applications (up to 6 stops)
- Stainless Steel, Oil Rubbed and Brass finishes with matching hall stations
- A.S.M.E compliant stop switch
- Compatible with any 24VDC system

Available Options

- Integrated Phone
- Plug and Play
- Dot Matrix Position Indicator



Porta Inc.

250 Hamilton Rd., Arlington Heights, IL 60005
Phone: (847)593-4900 Fax (847) 593-1394

MANUFACTURED BY:



ELEVATOR FIXTURES

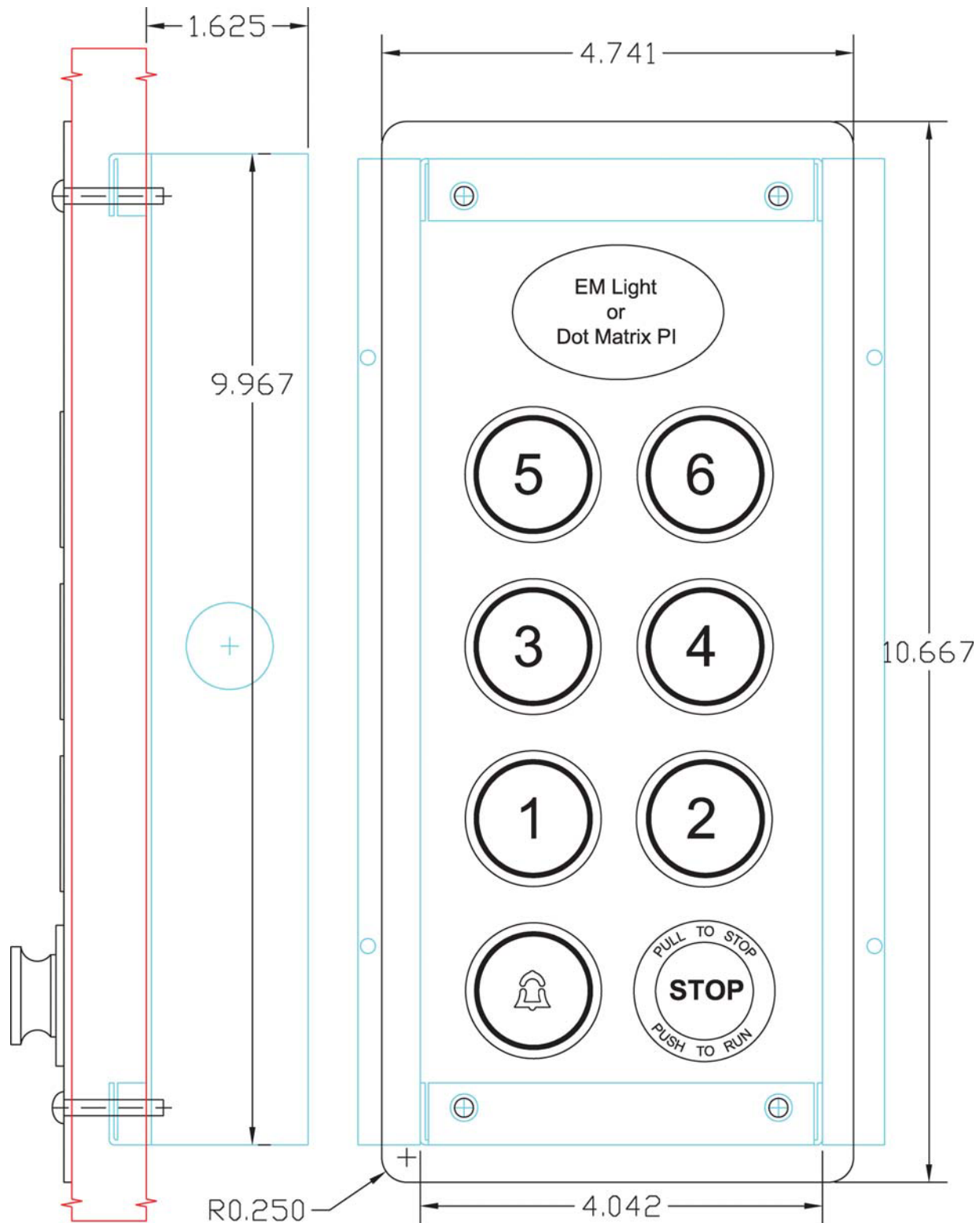

Porta Inc.

250 Hamilton Rd., Arlington Heights, IL 60005
Phone: (847)593-4900 Fax (847) 593-1394

SPEC.: COP ORG, REV. 3
DATE: 5-20-2008

MANUFACTURED BY:



ELEVATOR FIXTURES

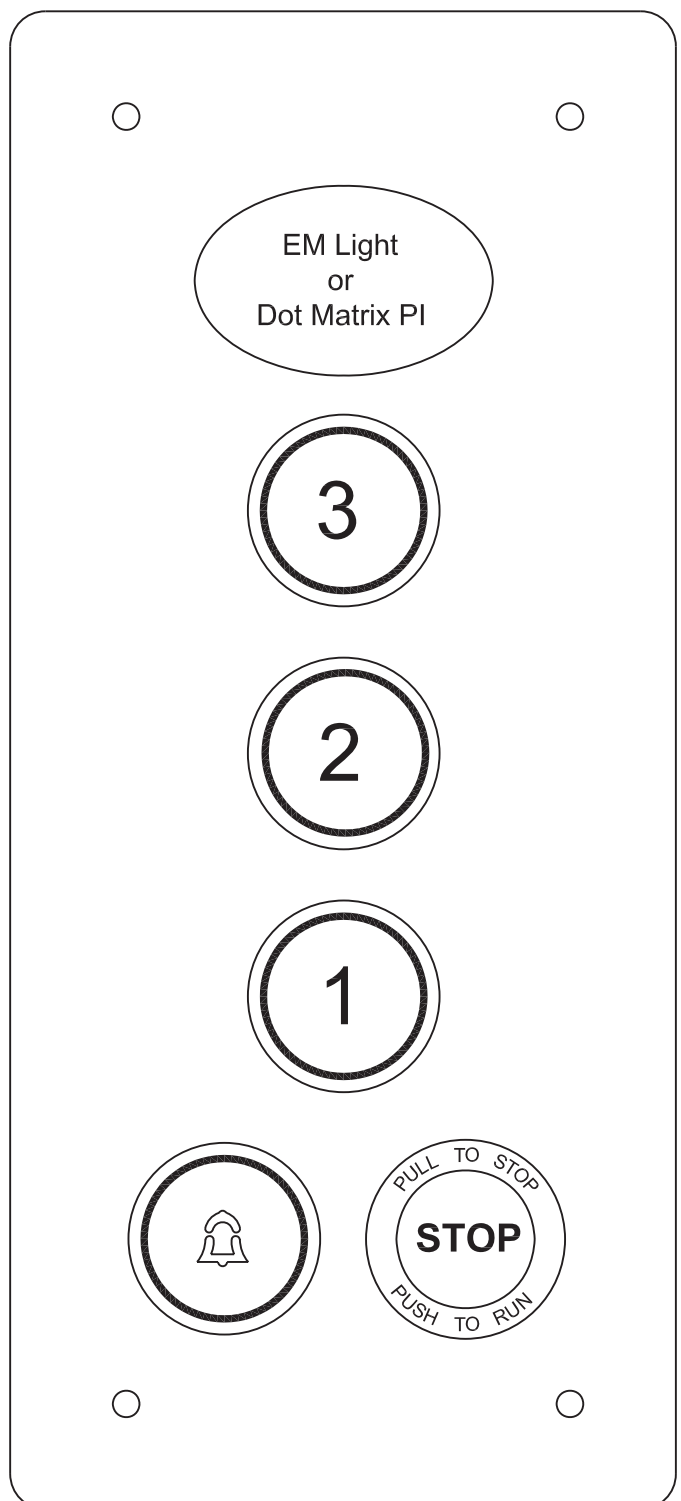
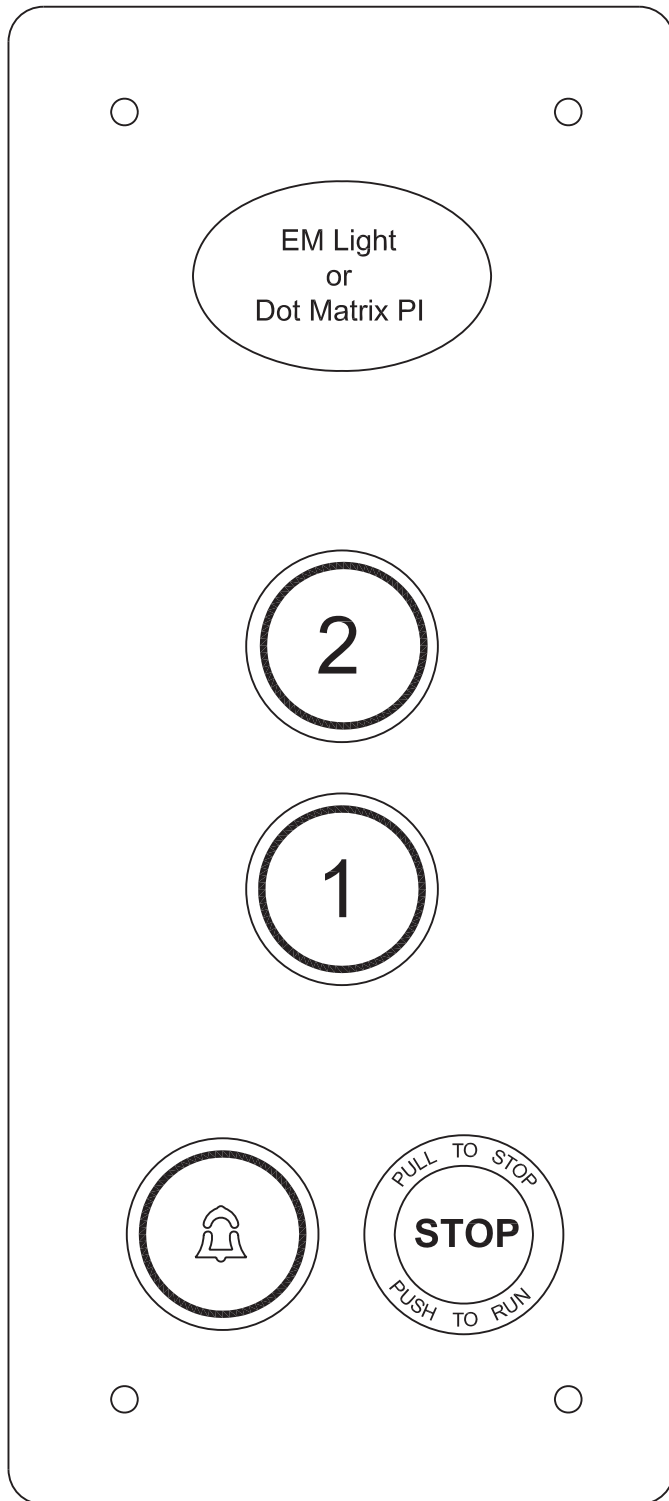

Porta Inc.

250 Hamilton Rd., Arlington Heights, IL 60005
Phone: (847)593-4900 Fax (847) 593-1394

SPEC.: COP ORG, REV. 3
DATE: 5-20-2008

MANUFACTURED BY:



ELEVATOR FIXTURES

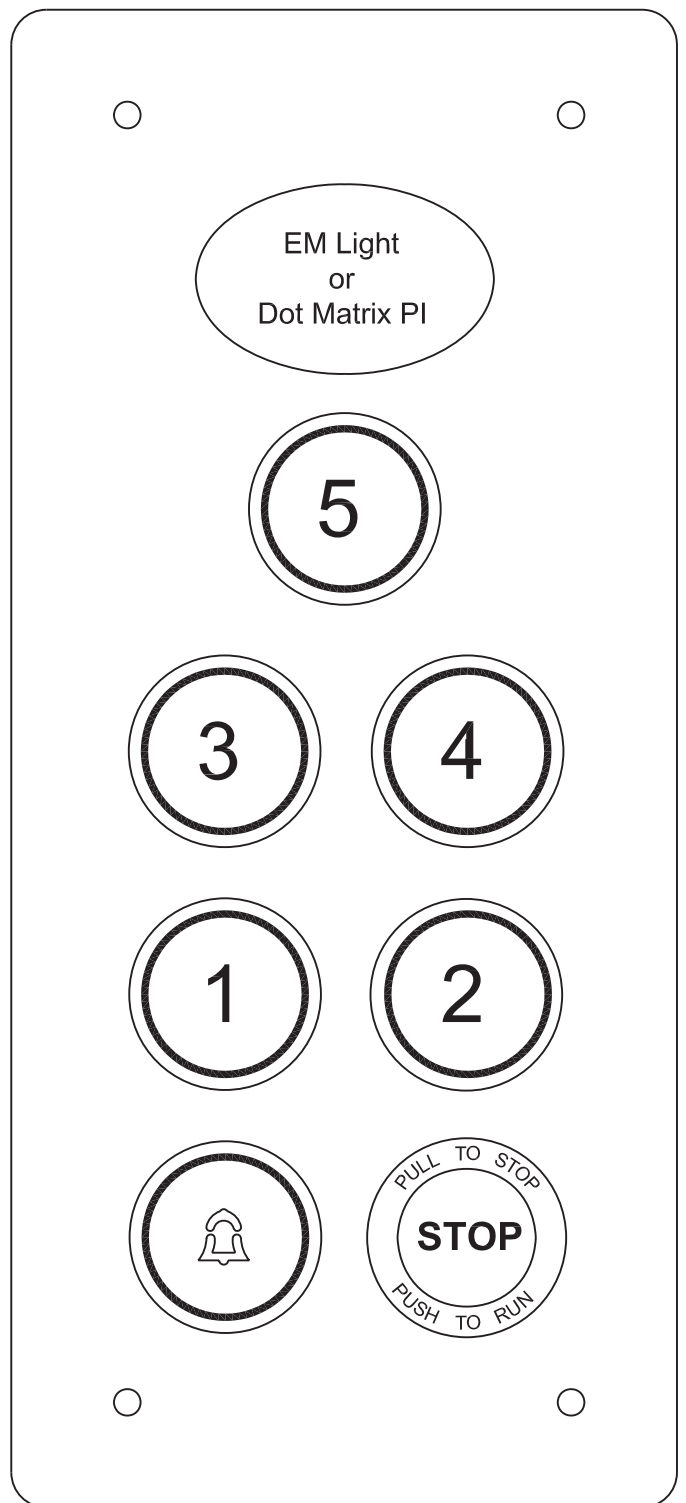
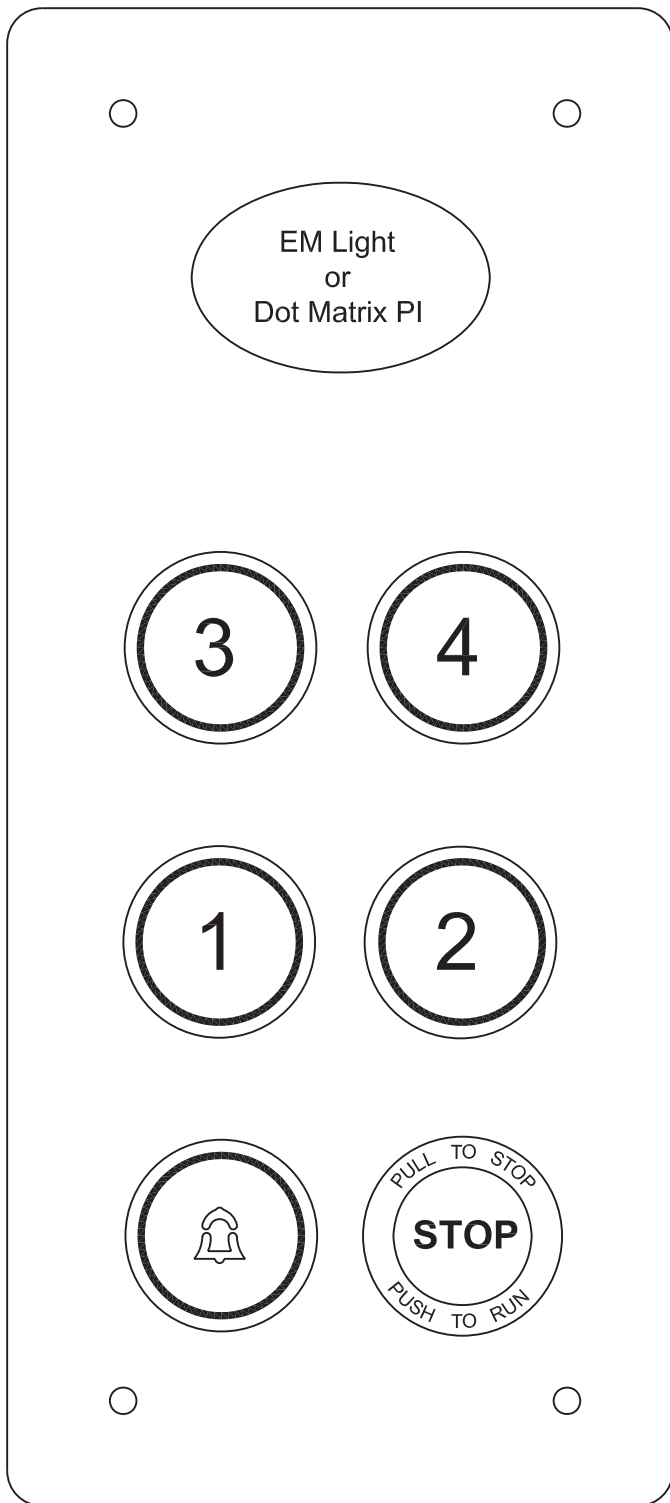

Porta Inc.

250 Hamilton Rd., Arlington Heights, IL 60005
Phone: (847)593-4900 Fax (847) 593-1394

SPEC.: COP ORG, REV. 3
DATE: 5-20-2008

MANUFACTURED BY:



ELEVATOR FIXTURES

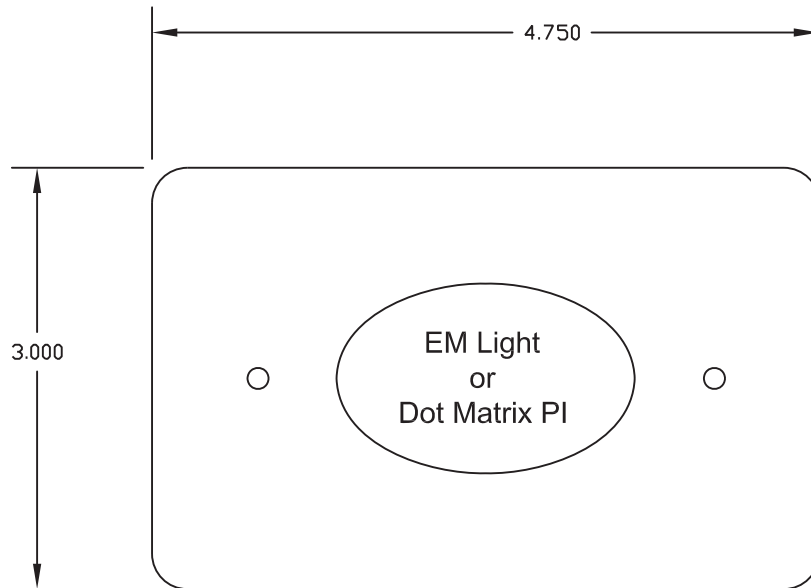

AUXILARY PANEL

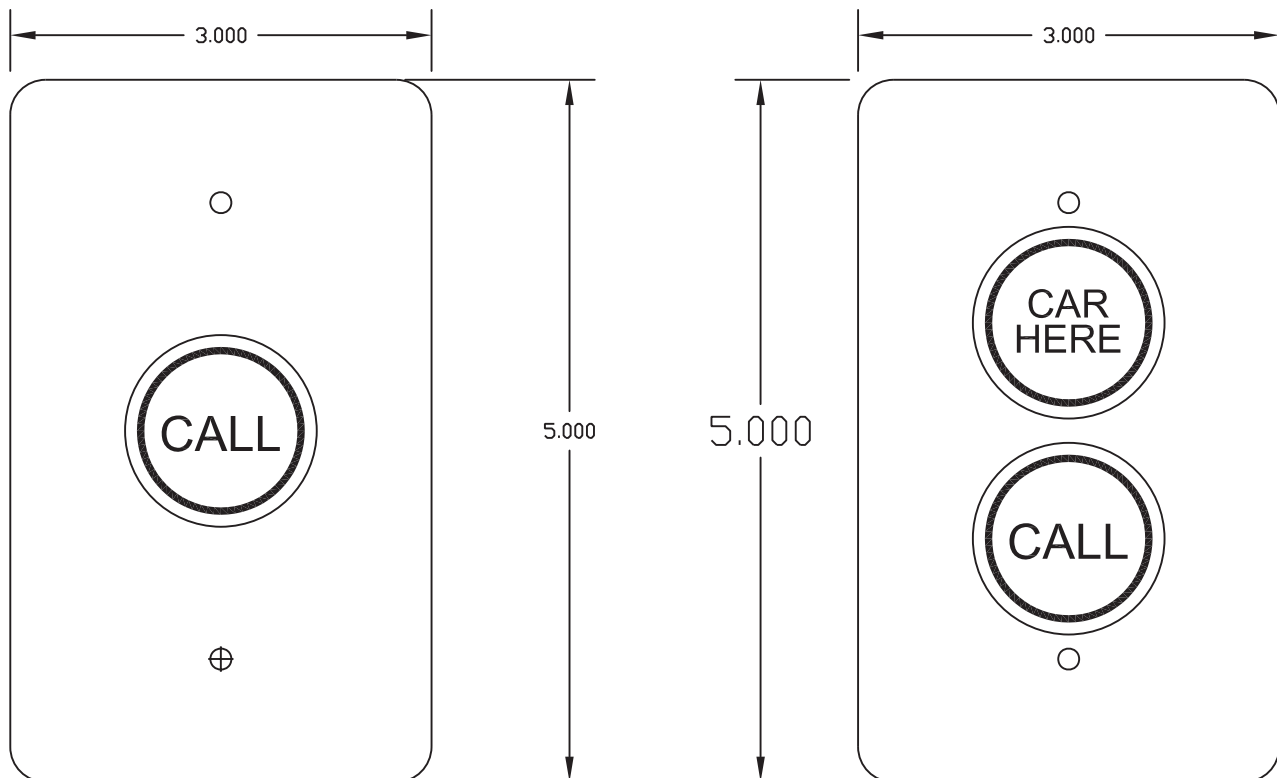

Porta Inc.

250 Hamilton Rd., Arlington Heights, IL 60005
Phone: (847)593-4900 Fax (847) 593-1394

SPEC.: COP ORG, REV. 3
DATE: 5-20-2008

MANUFACTURED BY:



ELEVATOR FIXTURES

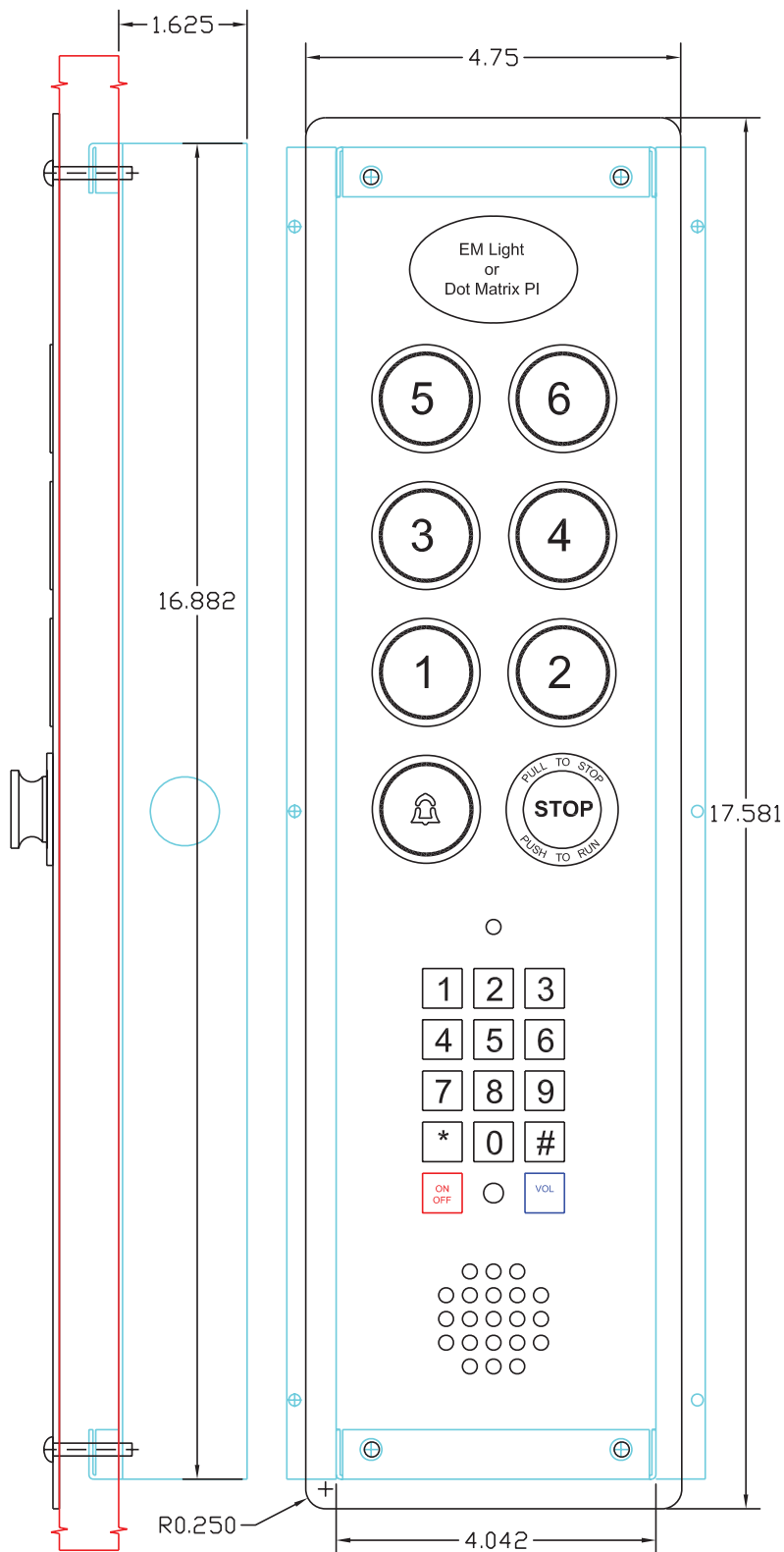

Porta Inc.

250 Hamilton Rd., Arlington Heights, IL 60005
 Phone: (847)593-4900 Fax (847) 593-1394

SPEC.: COP ORG, REV. 3
 DATE: 5-20-2008

MANUFACTURED BY:



ELEVATOR FIXTURES

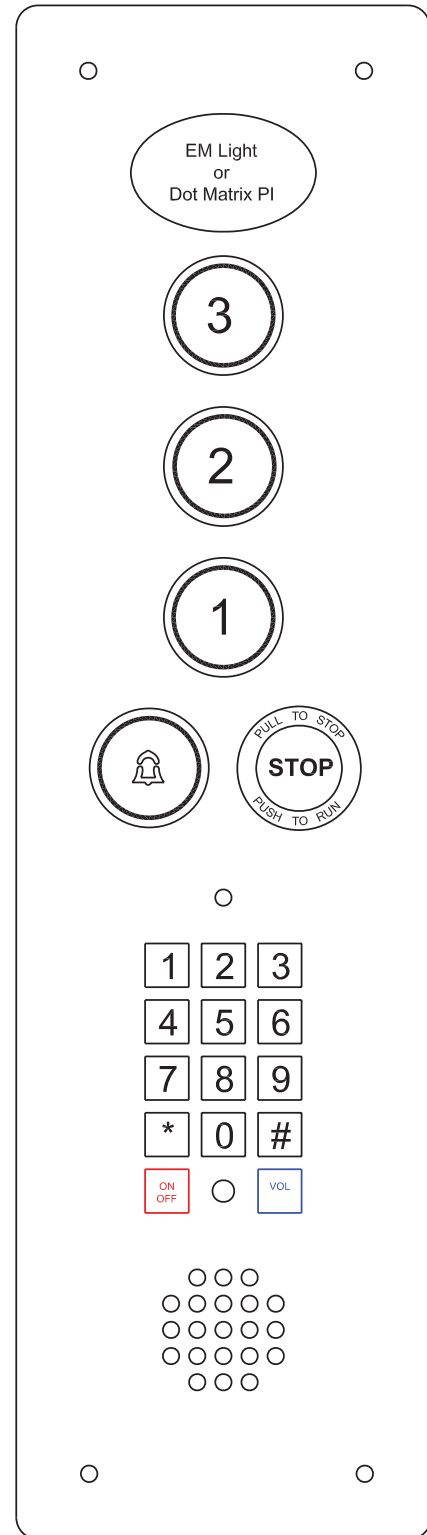
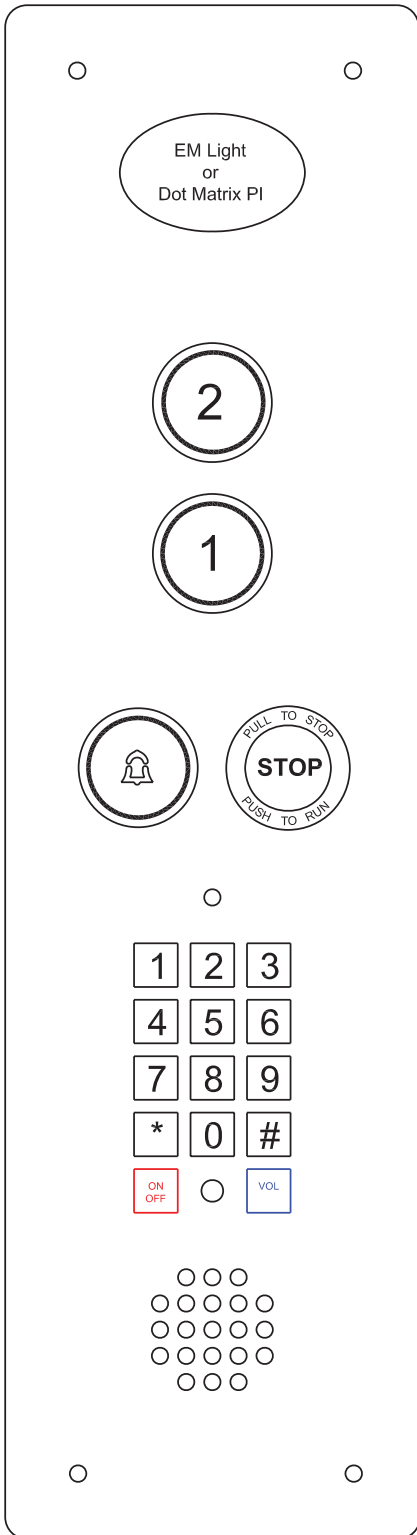

Porta Inc.

250 Hamilton Rd., Arlington Heights, IL 60005
Phone: (847)593-4900 Fax (847) 593-1394

SPEC.: COP ORG, REV. 3
DATE: 5-20-2008

MANUFACTURED BY:



ELEVATOR FIXTURES

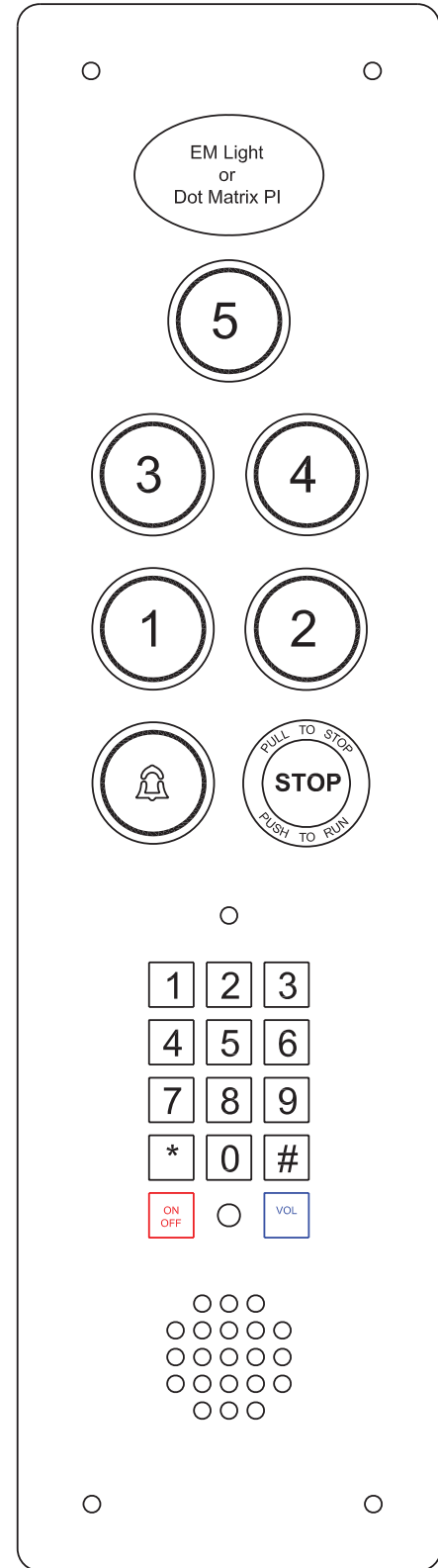
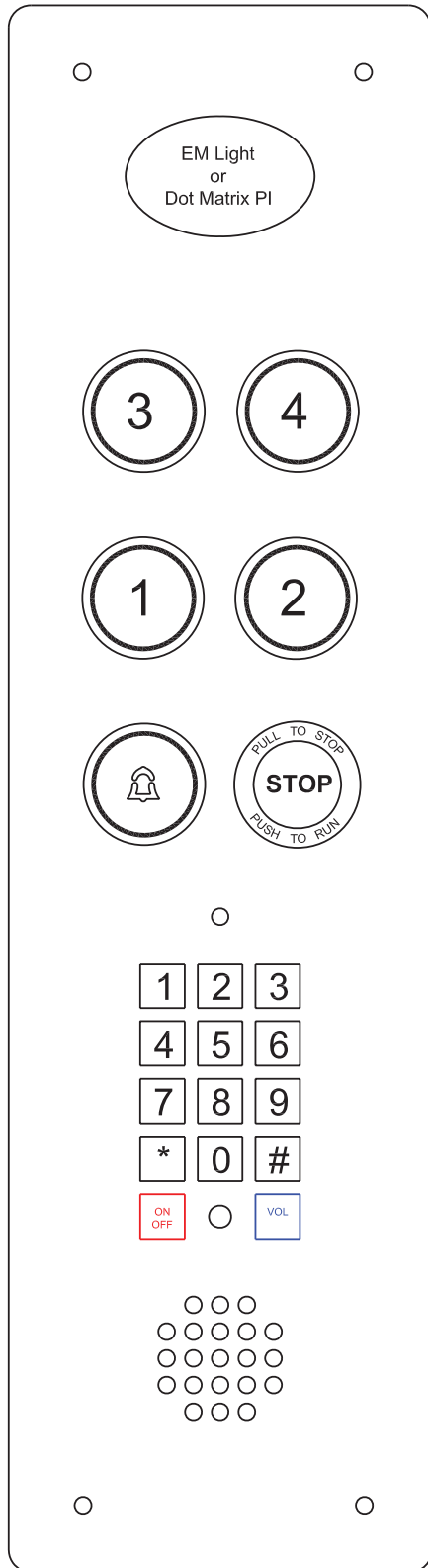

Porta Inc.

250 Hamilton Rd., Arlington Heights, IL 60005
Phone: (847)593-4900 Fax (847) 593-1394

SPEC.: COP ORG, REV. 3
DATE: 5-20-2008

MANUFACTURED BY:



ELEVATOR FIXTURES

CALL & ALARM BUTTONS

TERMINAL	WIRE COLOR	FUNCTION
1	BLK	LED (-)
2	RED	LED (+)
3	YEL	SW
4	GRN	SW

STOP SWITCH

	POSITION	
	RUN	STOP
BLK SWITCH BLOCK	CLOSED	OPEN
RED SWITCH BLOCK	OPEN	CLOSED

KEYED SWITCH

TERMINAL	COLOR	POSITION	
		ON	OFF
1	BLK	OPEN	CLOSED
2	RED	COM	COM
3	YEL	CLOSED	OPEN

HALL STATION CALL BUTTON

TERMINAL	FUNCTION
1	LED (-)
2	LED (+)
3	SW
4	SW

HALL STATION CAR HERE LIGHT

TERMINAL	FUNCTION
1	LED (-)
2	LED (+)



Porta Inc.

250 Hamilton Rd., Arlington Heights, IL 60005
Phone: (847)593-4900 Fax (847) 593-1394

SPEC.: COP CONN DIAG.
DATE: 03-13-2015

MANUFACTURED BY:

